

KENWOOD

STEREO INTEGRATED AMPLIFIER

KAF-3010R

KAF-1010

INSTRUCTION MANUAL

KENWOOD CORPORATION

Before applying power

 **Caution : Read this page carefully to ensure safe operation.**

KAF-3010R/1010 (En)

Units are designed for operation as follows.

- 2** **Europe and U.K.** **AC 230 V only**
***Other countries** **AC 110-120 /220-240 V switchable**

For the United Kingdom

Factory fitted moulded mains plug

1. The mains plug contains a fuse. For replacement, use only a 13-Amp ASTA-approved (BS1362) fuse.
2. The fuse cover must be refitted when replacing the fuse in the moulded plug.
3. Do not cut off the mains plug from this equipment. If the plug fitted is not suitable for the power points in your home or the cable is too short to reach a power point, then obtain an appropriate safety approved extension lead or adapter, or consult your dealer.
If nonetheless the mains plug is cut off, remove the fuse and dispose of the plug immediately, to avoid a possible shock hazard by inadvertent connection to the mains supply.

IMPORTANT

The wires in the mains lead are coloured in accordance with the following code.

Blue : Neutral

Brown : Live

Do not connect those leads to the earth terminal of a three-pin plug.

*For other countries

AC voltage selection

This unit operates on 110-120 or 220-240 volts AC . The AC voltage selector switch on the rear panel is set to the voltage that prevails in the area to which the unit is shipped. Before connecting the power cord to your AC outlet, make sure that the setting position of this switch matches your line voltage. If not, it must be set to your voltage in accordance with the following direction.

AC voltage selector switch

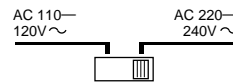





Move switch lever to match your line voltage with a small screwdriver or other pointed tool.

Note:

Our warranty does not cover damage caused by excessive line voltage due to improper setting of the AC voltage selector switch.

Safety precautions

WARNING : TO PREVENT FIRE OR ELECTRIC SHOCK, DO NOT EXPOSE THIS APPLIANCE TO RAIN OR MOISTURE.

  	CAUTION: TO REDUCE THE RISK OF ELECTRIC SHOCK, DO NOT REMOVE COVER (OR BACK). NO USER-SERVICEABLE PARTS INSIDE, REFER SERVICING TO QUALIFIED SERVICE PERSONNEL.
	THE LIGHTNING FLASH WITH ARROWHEAD SYMBOL, WITHIN AN EQUILATERAL TRIANGLE, IS INTENDED TO ALERT THE USER TO THE PRESENCE OF UNINSULATED "DANGEROUS VOLTAGE" WITHIN THE PRODUCT'S ENCLOSURE THAT MAY BE OF SUFFICIENT MAGNITUDE TO CONSTITUTE A RISK OF ELECTRIC SHOCK TO PERSONS.
	THE EXCLAMATION POINT WITHIN AN EQUILATERAL TRIANGLE IS INTENDED TO ALERT THE USER TO THE PRESENCE OF IMPORTANT OPERATING AND MAINTENANCE (SERVICING) INSTRUCTIONS IN THE LITERATURE ACCOMPANYING THE APPLIANCE.

Unpacking

Unpack the unit carefully and make sure that all accessories are put aside so they will not be lost.

Examine the unit for any possibility of shipping damage. If your unit is damaged or fails to operate, notify your dealer immediately. If your unit was shipped to you directly, notify the shipping company without delay. Only the consignee (the person or company receiving the unit) can file a claim against the carrier for shipping damage.

We recommend that you retain the original carton and packing materials for use should you transport or ship the unit in the future.



Special features

SOURCE DIRECT

Lets you enjoy high quality sound from the music source selected by the INPUT SELECTOR.

Contents

Caution : Read the pages marked  carefully to ensure safe operation.

Before applying power	2
 Before applying power	2
 Safety precautions	2
Special features	3
System connection	4
The system control connections	5
Connection of speakers	6
Controls and indicators	7
Main unit	7
Remote control unit	8
Operation of remote control unit	9
Playing music	10
Normal Playback	10
Sound adjustment functions	11
To mute sound temporarily	11
Adjusting the left/right sound balance	11
Adjusting the tone	11
Emphasizing deep bass (LOUDNESS)	11
To listen through headphones	12
Listening to high quality sound from a music source (SOURCE DIRECT)	12
Recording	13
To record a music source	13
In case of difficulty	14
 Specifications	15

Accessories

Remote control unit (1)
(KAF-3010R only)

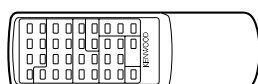

Batteries (R6/SUM-3) (2)
(KAF-3010R only)

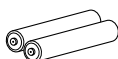

AC plug adaptor (1)

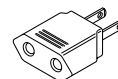

Use to adapt the plug on the power cord to the shape of the wall outlet. (Accessory only for regions where use is necessary.)

System connection

KAF-3010R/1010 (En)

4

Make connections as shown below.
When connecting the related system components, refer also to the instruction manuals of the related components.
Do not plug in the power lead until all connections are completed.

Malfunction of microcomputer



If operation is not possible or erroneous display appears even though all connections have been made properly, reset the microcomputer referring to "In case of difficulty".

- 14

SYSTEM CONTROL selector switch and terminals (KAF-3010R only)

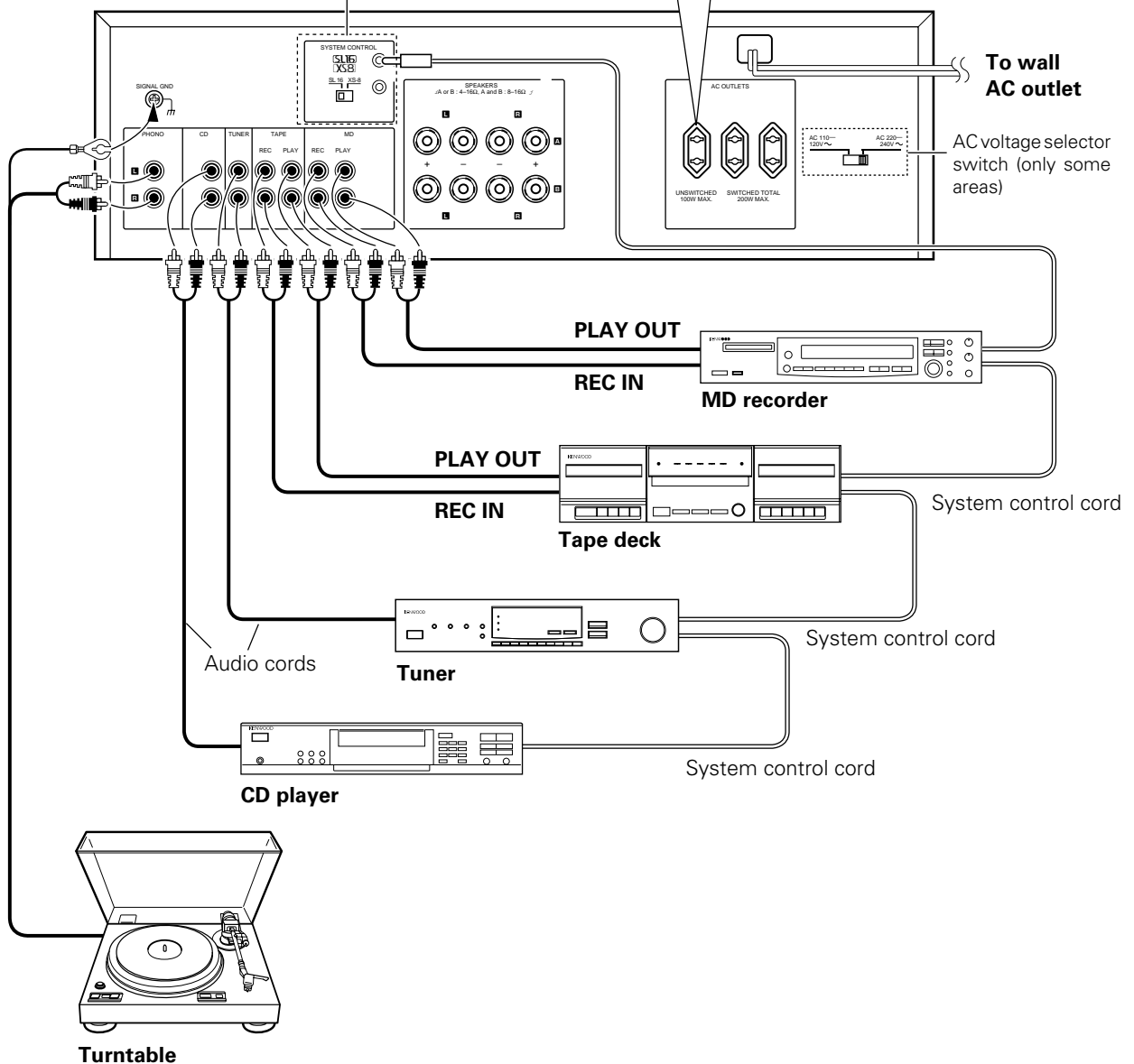

* Caution (for U.K.)

When using the AC outlets equipped with unit, be sure to consult your dealer for the corresponding plug.

AC outlets (KAF-3010R only)

Shape of AC outlets



To wall AC outlet

AC voltage selector switch (only some areas)

Caution regarding placement

To maintain proper ventilation, be sure to leave a space around the unit (from the largest outer dimensions including projections) equal to, or greater than, shown below.

Left and right panels: 10 cm, Rear panel: 10 cm, Top panel: 50 cm

About the AC outlet for other components (KAF-3010R only)

SWITCHED outlet (maximum capacity 200 W)

You can connect a power cord from a cassette deck, record player, or CD player (etc.). If you leave the POWER switch of that component in the ON position, it will turn ON/OFF together with the REMOTE POWER key on this unit, for your convenience. Do not connect a component that consume more than 200 W total.

The system control connections (only for KAF-3010R)

5

Connecting system control cords after connecting a KENWOOD audio component system lets you take advantage of convenient system control operations.

There are two KENWOOD system control modes. Make connections according to the groups of terminal symbols shown below.

[XS8] Mode : lets you combine [XR], [XS], and [XS8] terminals

[SL16] Mode : for [SL16] terminals only

This unit corresponds to [XS8] and to [SL16].

- When all units in system control connection are set to [XS8] mode, set the SYSTEM CONTROL selector switch on the rear to the [XS8] side and connect.
- When all units in system control connection are set to [SL16] mode, set the SYSTEM CONTROL selector switch on the rear to the [SL16] side and connect.

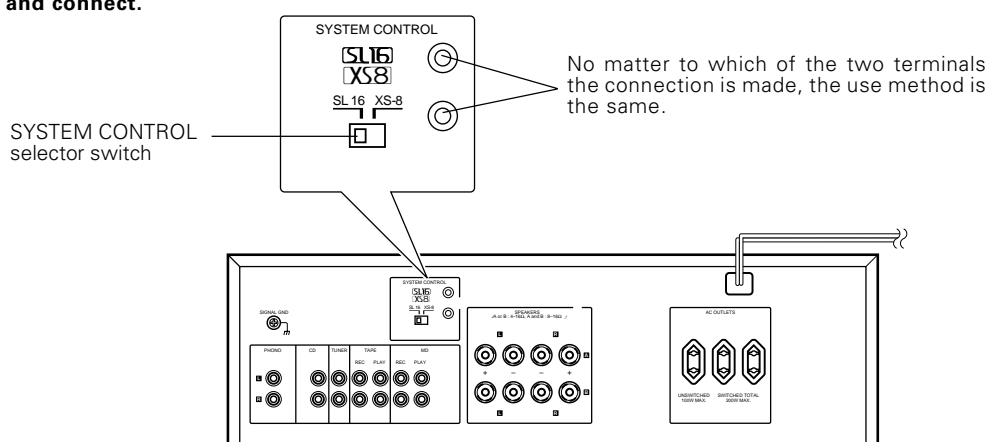

1. [SL16] equipment cannot be combined with [XR], [XS], and [XS8] equipment for system operations. If your equipment consists of this kind of combination, please do not connect any system control cords. Even without system control cords, normal operations can be carried out without affecting performance.
2. If your amp or receiver does not have a system control terminal, do not connect any system control cords to the system control terminals on the other components.
3. Do not connect system control cords to any components other than those specified by KENWOOD. It may cause a malfunction and damage your equipment.
4. Be sure the system control plugs are inserted all the way in to the system control terminals.

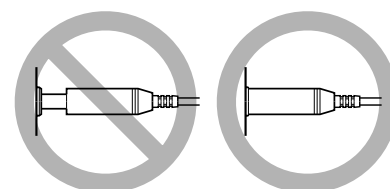

The system control operations

Remote Control

The remote control supplied with this unit can also be used to control the other components in the system.

Automatic Operation (except [XR] equipment)

Automatically switches the input selector on the amp or receiver when you start playback from this unit.

Synchronized Recording (except [XR] equipment)

Lets you synchronize recording with the start of playback when recording from CD, MD, or LD.

6 Connection of speakers

Connect the speakers as shown below, ensuring that bare wires do not make contact with other terminals.

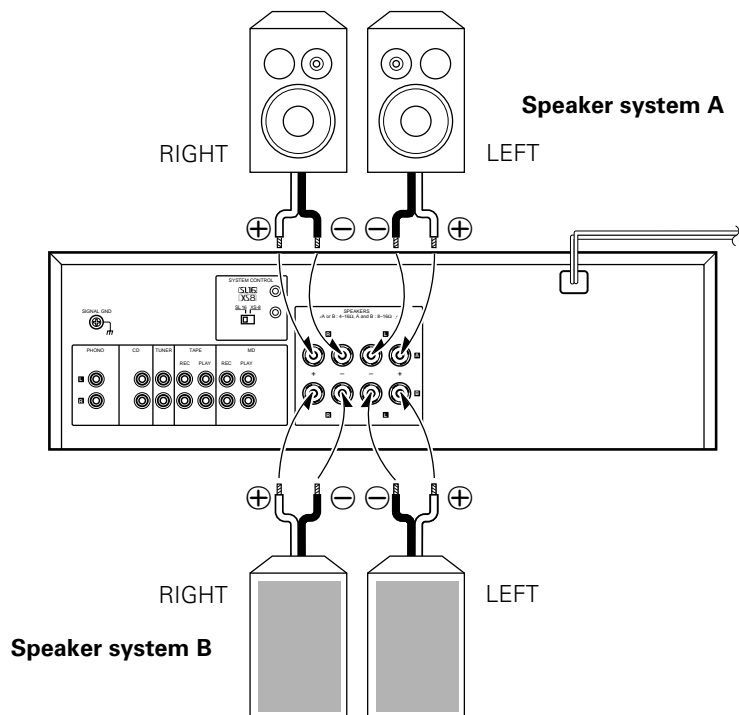
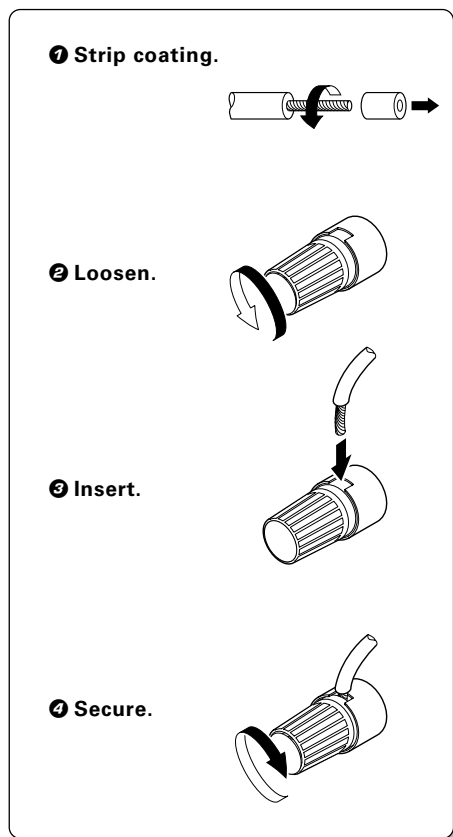

- Never short-circuit the + and – speaker cords.
- If the left and right speakers are connected inversely or if the speaker cords are connected with reversed polarity, the sound becomes unnatural with ambiguous acoustic image positioning. Be sure to connect the speakers and speaker cords correctly.

Speaker impedance

When only one pair of speakers is connected to A or B speaker terminals, use the speakers having an impedance of 4 to 16 Ω .

When two pairs of speakers are connected to both A and B terminals simultaneously, use the speakers having an impedance of 8 to 16 Ω . In this case, connecting a speaker having an impedance of less than 8 Ω may cause malfunction of the amplifier.



- 1 Connect all cords firmly. If connections are loose, there could be loss of sound or noise produced.
- 2 When plugging and unplugging connection cords, be sure to first remove the power cord from the AC outlet. Plugging / unplugging connection cords without removal of the power cord can cause malfunctions or damage to the unit.
- 3 Do not connect up a power source which is larger than that indicated on the socket at the rear of the unit.

Main unit

7

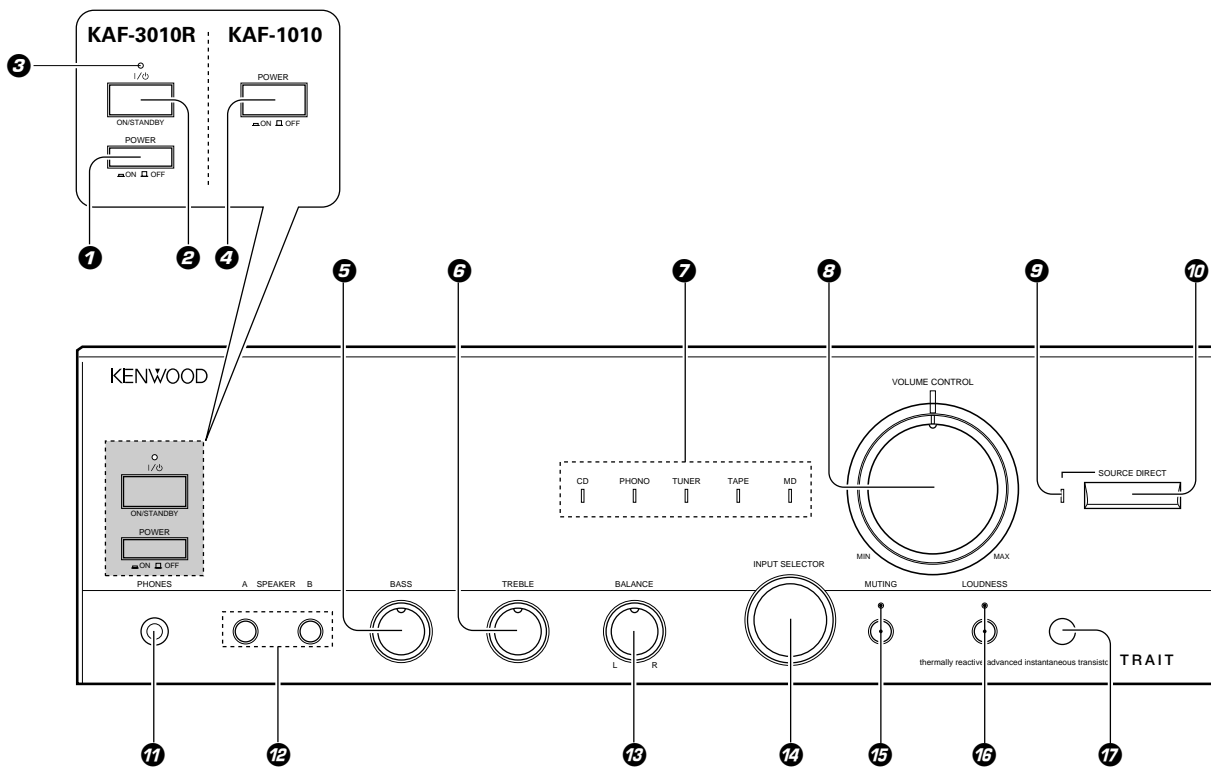

1 POWER switch (KAF-3010R)

Usually leave this switch to the on position.
When the unit is not to be used for a long period of time, set the switch to the **OFF** position for safety.

2 ON/STANDBY key (KAF-3010R)

This key effective when the **POWER** key is set to the on (standby) position, and pressing this key turns power **ON** and off (standby).

3 Standby indicator (KAF-3010R)

4 POWER switch (KAF-1010)

5 BASS knob

To adjust low frequencies.

6 TREBLE knob

To adjust high frequencies.

7 INPUT indicator

An indicator lights for the source selected with the **INPUT SELECTOR** knob.

8 VOLUME CONTROL knob

Adjust the volume.

9 SOURCE DIRECT indicator

10 SOURCE DIRECT key

To listen to a source with high quality sound.

11 PHONES jack

Used for headphone listening.

12 SPEAKERS A/B switches

Press to select the A and/or B speaker systems.

13 BALANCE knob

Adjust the volume balance between left and right.

14 INPUT SELECTOR knob

Turn to select the input sources.

15 MUTING key/indicator

Mute the sound temporarily.

16 LOUDNESS key/indicator

Use to emphasize deep bass sounds.

17 Remote sensor (KAF-3010R only)

About the standby indicator (KAF-3010R only)

This unit has a standby indicator that lights to show that a small amount of current is being supplied to the unit in order to preserve the memory. This is called the Standby mode. When the Standby indicator is lit, the amplifier can be switched **ON / STANDBY** from the remote control.

8 Remote control unit (KAF-3010R only)

The  part of the illustration designates keys that can be used to operate KENWOOD components connected with the system control. The rest of the illustration designates keys that have the same functions as the keys on the main unit.

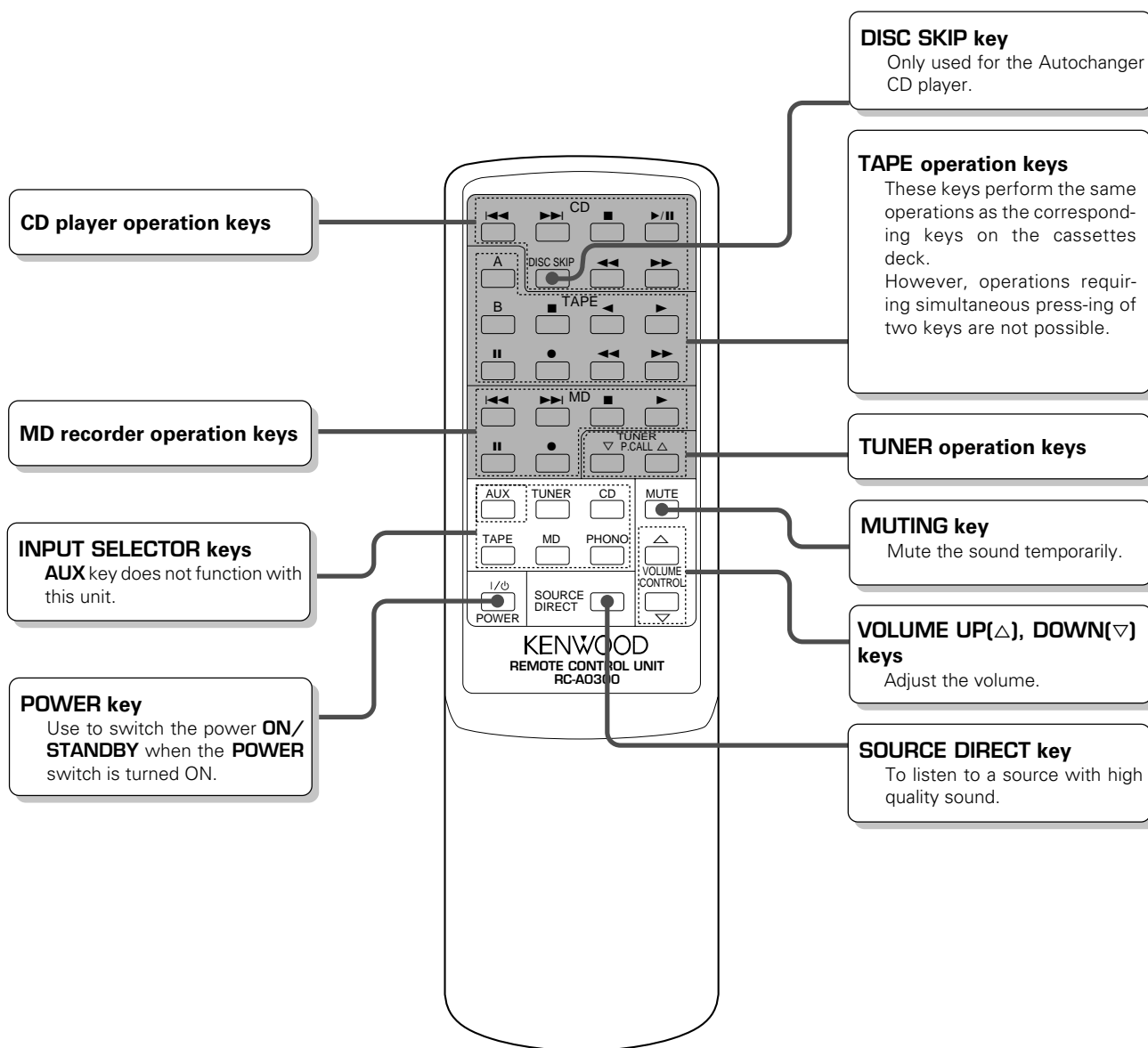

Model: RC-A0300
Infrared ray system

Loading batteries

1 Remove the cover.

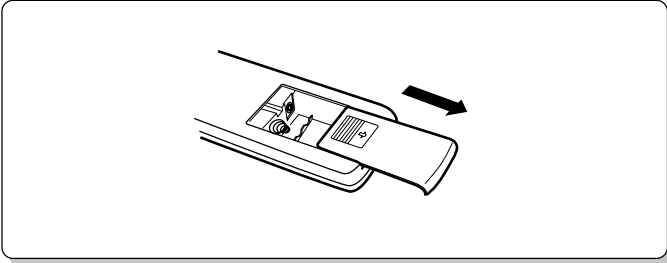

2 Insert batteries.

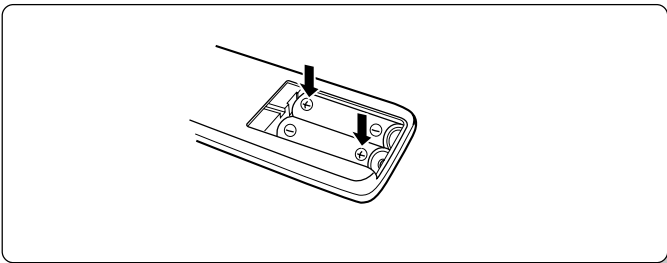

3 Close the cover.

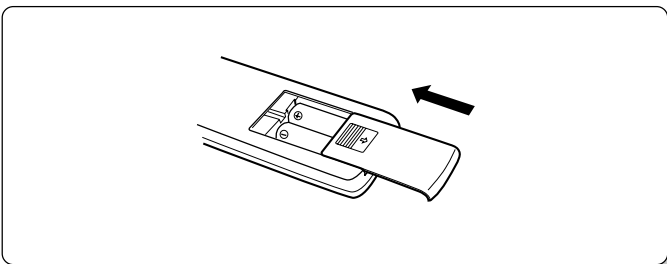

- Insert two AA-size (R6 / SUM-3) batteries as indicated by the polarity marking.

Operation procedure

Pressing the **POWER** key on the remote control when the standby indicator is lit turns **ON** the power. After the power comes **ON**, press the key you want to operate.

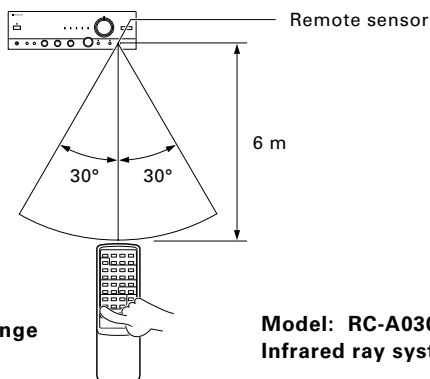

Operating range
(approx.)

Model: RC-A0300
Infrared ray system

- When two operation keys on the remote control unit are pressed successively, press each key securely reserving an interval of more than 1 second for each press.



1. The supplied batteries are intended for use in operation checks. Therefore, their lives may be shorter than ordinary batteries.
2. When the remote-controllable distance gets shorter than before, replace both batteries with new ones.
3. Malfunction may occur if direct sunlight or the light of a high-frequency lighting fluorescent lamp enters the remote control light sensor. In such a case, change the system installation position to prevent the malfunction.

Playing music

10

Preparation

KAF-3010R

KAF-1010

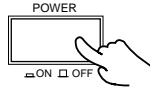
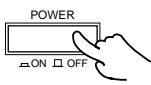

- Set the **MAIN POWER** key to the **ON** position.
- When the **POWER** switch of the **KAF-3010R** is left **ON** at all times, the power can be switched on and off with the remote control unit.

The figure shows an example for the KAF-3010R.

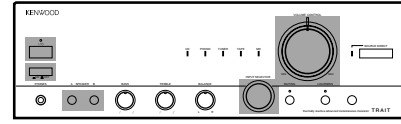
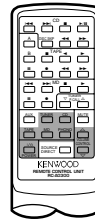

 : Keys or controls to be used in this operation

Normal playback

1 Turn the power ON. (KAF-3010R only)

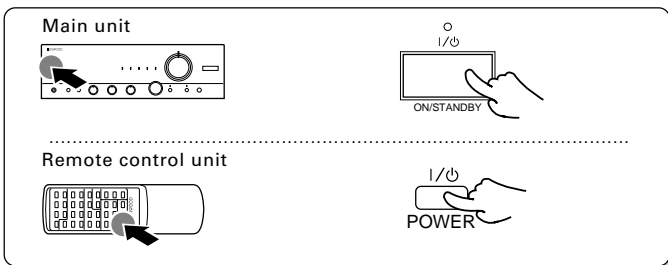

2 Select the SPEAKERS switch setting.

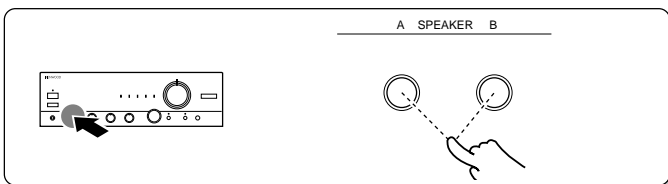

3 Select the input source.

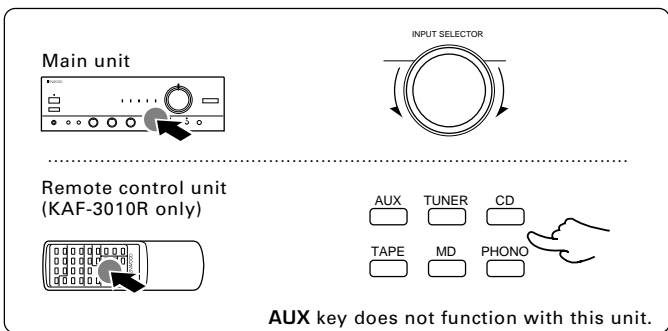

4 Play the selected source.

5 Adjust the volume.

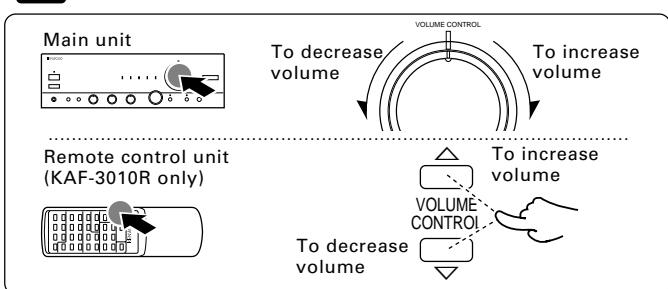

A OFF, B OFF:

Set to this position when listening to the sound with stereo headphones only. Sound cannot be heard from the speakers.

A ON, B OFF:

Set to this position when listening to the sound with the speakers connected to the **SPEAKERS A** terminals.

A OFF, B ON:

Set to this position when listening to the sound with the speakers connected to the **SPEAKERS B** terminals.

A ON, B ON:

Set to this position when listening to the two pairs of speakers connected to both **SPEAKERS A** and **SPEAKERS B** terminals simultaneously.

One lights.

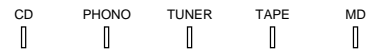

- The indicator for the selected source lights.

- **KAF-1010** : When the power is switched on, the input selector position is set to **TUNER**.

The figure shows an example for the KAF-3010R.

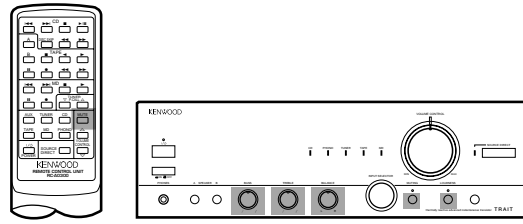

 : Keys or controls to be used in this operation

To mute sound temporarily

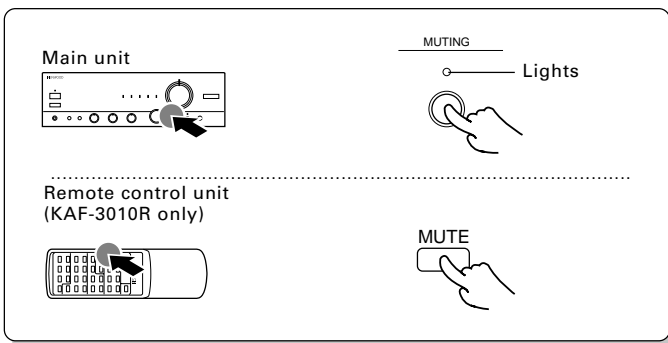

- When you press again, the volume returns to the original level and the **MUTING** indicator goes out.

Adjusting the left/right sound balance

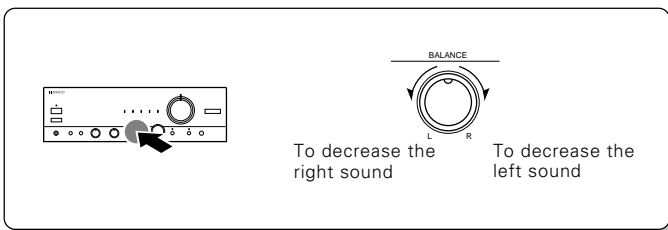

- Make sure the **SOURCE DIRECT** indicator is not lit. → [12](#)

Adjusting the tone

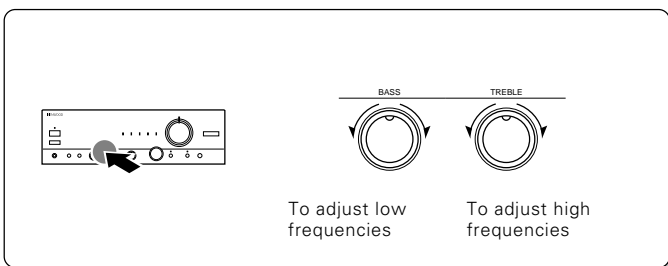

- Make sure the **SOURCE DIRECT** indicator is not lit. → [12](#)

Emphasizing deep bass (**LOUDNESS**)

Lets you emphasize the sound of deep bass when listening at low volumes.

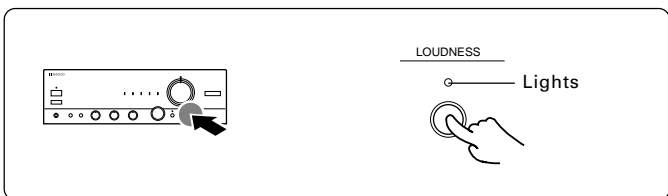

- Make sure the **SOURCE DIRECT** indicator is not lit. → [12](#)

To cancel **LOUDNESS**

Press the **LOUDNESS** key again.

- The **LOUDNESS** indicator goes out.

The figure shows an example for the KAF-3010R.

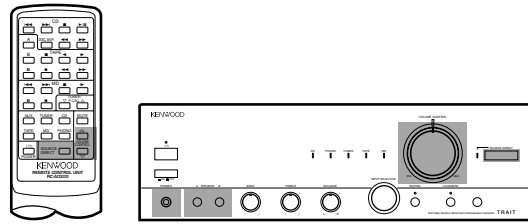

: Keys or controls to be used in this operation

To listen through headphones

1 Set both of the SPEAKERS switches to OFF.

A SPEAKER B

2 Plug headphones.

PHONES

3 Adjust the volume.

Main unit

VOLUME CONTROL

To decrease volume

MIN MAX

To increase volume

Remote control unit (KAF-3010R only)

To increase volume

VOLUME CONTROL

To decrease volume

Listening to high quality sound from a music source (SOURCE DIRECT)

Use this mode to avoid unnecessary circuitry during playback when you want to listen to high quality sound.

Main unit

SOURCE DIRECT

Remote control unit (KAF-3010R only)

SOURCE DIRECT



- Tone adjustment, balance and **LOUDNESS** do not work when **SOURCE DIRECT** is ON (when the **SOURCE DIRECT** indicator is lit).
- The **SOURCE DIRECT** function takes precedence, regardless of the source selected by the **INPUT SELECTOR**.

To cancel SOURCE DIRECT

Press the **SOURCE DIRECT** key again.

- The **SOURCE DIRECT** indicator goes out.

The figure shows an example for the KAF-3010R.

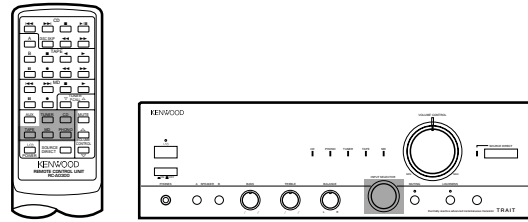

 : Keys or controls to be used in this operation

To record a music source

❶ Select the source to be recorded.



❷ Put the cassette deck or MD recorder in record-pause mode.

❸ Play the source and start recording.

One lights.

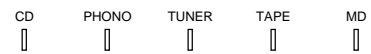

- The indicator for the selected source lights.
- When **TAPE** is selected with the **INPUT SELECTOR**, recording is possible with the MD recorder.
- When **MD** is selected with the **INPUT SELECTOR**, recording is possible with the Tape deck.

What appears to be a malfunction may not always be serious. If your unit should not perform as expected, consult the table below to see if the problem can be corrected before seeking help from your dealer or service representative.





Operation to reset

The microcomputer may fall into malfunction (impossibility to operate, erroneous display, etc.) when the power cord is unplugged while power is ON or due to an external factor. In this case, execute the following procedure to reset the microcomputer and return it to normal condition.









Set the **POWER** to OFF then, while holding down the **SOURCE DIRECT** key, set the **POWER** switch to ON.

- Please note that resetting the microcomputer clears the contents stored in it and returns it to the condition when it left the factory.

Remote control unit (KAF-3010R only)

Symptom	Cause	Remedy
Remote control operation is not possible	<ul style="list-style-type: none"> • Batteries are exhausted. • The remote control unit is too far away from the main system, controlling angle is too large, or there is an obstacle in between. • The audio cords and system control cords are not connected properly. • The source component to be operated does not contain the tape(s) or CD. • The POWER switch is set to OFF. 	<ul style="list-style-type: none"> • Replace with new batteries. →  • Operate the remote control unit within the controllable range. →  • Connect properly referring to "System connection". →  →  • Place the tape(s) or CD in the source component to be played. • Set the POWER switch to ON. → 

Amplifier

Symptom	Cause	Remedy
Sound is not output.	<ul style="list-style-type: none"> • The speaker cords are disconnected. • The VOLUME CONTROL is set to the minimum position. • MUTING is ON. (The MUTING indicator is blinking) • The SPEAKERS switches are set to OFF. • The system control cords are not fully connected. 	<ul style="list-style-type: none"> • Connect them properly referring to "System connection". →  • Adjust the volume to a proper level. →  • Press the MUTING key to OFF. →  • Set the SPEAKERS switch(es) to ON. →  • Check the system control connections. →  → 
The standby indicator blinks and sound is not output. (KAF-3010R) The MUTING indicator blinks and sound is not output. (KAF-1010)	<ul style="list-style-type: none"> • Speaker cords are short-circuited. 	<ul style="list-style-type: none"> • Turn the power off, eliminate the short-circuiting, then turn on the power again.
Sound is not output from one of the speakers.	<ul style="list-style-type: none"> • The speaker cord is disconnected. • The BALANCE control is set to an extreme position. 	<ul style="list-style-type: none"> • Connect it properly referring to "System connection". →  • Adjust the Left/Right balance. → 

Speaker protection circuit

When this unit's power is turned ON with the speaker cable short-circuited, the speaker protection functions. If the standby indicator blinks (KAF-3010R) or the **MUTING** indicator blinks (KAF-1010) and no sound occurs, turn the power OFF, remove the short-circuit, then turn the power ON again.



Do not use contact cleaners because it could cause a malfunction. Be specially careful against contact cleaners containing oil, for they may deform the plastic components.

KAF-3010R

Rated output power	
(DIN) 1 kHz	
at 8 Ω	70 W + 70 W
at 4 Ω	100 W + 100 W
(IEC/DIN) from 63 Hz to 12.5 kHz, 0.7 % T.H.D.	
at 8 Ω	65 W + 65 W
at 4 Ω	100 W + 100 W
Effective output power	
Except UK and Europe	
(EIAJ) 1 kHz, 10 % T.H.D.	
at 8 Ω	95 W + 95 W
at 4 Ω	130 W + 130 W
Damping factor	42 (50 Hz)
Total harmonic distortion	
	0.04 % (20~20 kHz, 50 W, 4 Ω)
	0.01 % (1 kHz, 50 W, 4 Ω)
Frequency response (IHF'78)	
CD, TUNER, TAPE, MD	5 Hz~85 kHz, +0 dB, -3 dB
PHONO 'RIAA' response	20 Hz~20 kHz, +1.0 dB, -1.0 dB
Maximum input level	
PHONO (MM)	100 mV, 0.5 % T.H.D. at 1 kHz
Signal to noise ratio	
PHONO (MM)	72 dB (IHF'66)
CD, TUNER, TAPE, MD	100 dB (IHF'66)
PHONO (MM)	60 dB (DIN, 50 mW output)
CD, TUNER, TAPE, MD	60 dB (DIN, 50 mW output)
Input sensitivity/impedance	
PHONO (MM)	2.5 mV/33 kΩ
CD, TUNER, TAPE, MD	200 mV/47 kΩ
Tone control	
BASS	±10 dB (at 100 Hz)
TREBLE	±10 dB (at 10 kHz)
LOUDNESS control	
VOLUME at -30 dB level	+9 dB (at 100 Hz)
Output level/impedance	
TAPE REC, MD REC	200 mV/2.7 kΩ
General	
Power consumption	200 W
AC outlet	
SWITCHED	2 (total 200 W max.)
UNSWITCHED	1 (100 W max.)
Dimensions	W: 440 mm
	H: 145 mm
	D: 400 mm
Weight (net)	8.3 kg

KAF-1010

Rated output power	
(DIN) 1 kHz	
at 8 Ω	40 W + 40 W
at 4 Ω	60 W + 60 W
(IEC/DIN) from 63 Hz to 12.5 kHz, 0.7 % T.H.D.	
at 8 Ω	40 W + 40 W
at 4 Ω	60 W + 60 W
Effective output power	
Except UK and Europe	
(EIAJ) 1 kHz, 10 % T.H.D.	
at 8 Ω	55 W + 55 W
at 4 Ω	75 W + 75 W
Damping factor	42 (50 Hz)
Total harmonic distortion	
	0.06 % (20~20 kHz, 30 W, 4 Ω)
	0.01 % (1 kHz, 30 W, 4 Ω)
Frequency response (IHF'78)	
CD, TUNER, TAPE, MD	5 Hz~85 kHz, +0 dB, -3 dB
PHONO 'RIAA' response	20 Hz~20 kHz, +1.0 dB, -1.0 dB
Maximum input level	
PHONO (MM)	100 mV, 0.5 % T.H.D. at 1 kHz
Signal to noise ratio	
PHONO (MM)	65 dB (IHF'66)
CD, TUNER, TAPE, MD	98 dB (IHF'66)
PHONO (MM)	60 dB (DIN, 50 mW output)
CD, TUNER, TAPE, MD	60 dB (DIN, 50 mW output)
Input sensitivity/impedance	
PHONO (MM)	2.5 mV/33 kΩ
CD, TUNER, TAPE, MD	200 mV/47 kΩ
Tone control	
BASS	±10 dB (at 100 Hz)
TREBLE	±10 dB (at 10 kHz)
LOUDNESS control	
VOLUME at -30 dB level	+9 dB (at 100 Hz)
Output level/impedance	
TAPE REC, MD REC	200 mV/2.7 kΩ
General	
Power consumption	140 W
Dimensions	W: 440 mm
	H: 145 mm
	D: 400 mm
Weight (net)	6.8 kg



1. KENWOOD follows a policy of continuous advancements in development. For this reason specifications may be changed without notice.
2. The full performance may not be exhibited in extremely cold location (under a water-freezing temperature).

KENWOOD

For your records

Record the serial number, found on the back of the unit, in the spaces designated on the warranty card, and in the space provided below. Refer to the model and serial numbers whenever you call upon your dealer for information or service on this product.

Model _____ Serial Number _____